

T h e P h a n t o m L a b o r a t o r y

## C a t p h a n ® 604 M a n u a l

Copyright © 2020

### WARRANTY

THE PHANTOM LABORATORY INCORPORATED (“Seller”) warrants that this product shall remain in good working order and free of all material defects for a period of one (1) year following the date of purchase. If, prior to the expiration of the one (1) year warranty period, the product becomes defective, Buyer shall return the product to the Seller at:

By Truck

The Phantom Laboratory, Incorporated  
2727 State Route 29  
Greenwich, NY12834

By Mail

The Phantom Laboratory, Incorporated  
PO Box 511  
Salem, NY 12865-0511

Seller shall, at Seller’s sole option, repair or replace the defective product. The Warranty does not cover damage to the product resulting from accident or misuse.

IF THE PRODUCT IS NOT IN GOOD WORKING ORDER AS WARRANTED, THE SOLE AND EXCLUSIVE REMEDY SHALL BE REPAIR OR REPLACEMENT, AT SELLER’S OPTION. IN NO EVENT SHALL SELLER BE LIABLE FOR ANY DAMAGES IN EXCESS OF THE PURCHASE PRICE OF THE PRODUCT. THIS LIMITATION APPLIES TO DAMAGES OF ANY KIND, INCLUDING, BUT NOT LIMITED TO, DIRECT OR INDIRECT DAMAGES, LOST PROFITS, OR OTHER SPECIAL, INCIDENTAL, OR CONSEQUENTIAL DAMAGES, WHETHER FOR BREACH OF CONTRACT, TORT OR OTHERWISE, OR WHETHER ARISING OUT OF THE USE OF OR INABILITY TO USE THE PRODUCT. ALL OTHER EXPRESS OR IMPLIED WARRANTIES, INCLUDING, BUT NOT LIMITED TO, THE IMPLIED WARRANTY OF MERCHANT ABILITY AND FITNESS FOR PARTICULAR PURPOSE, ARE HEREBY DISCLAIMED.

### WARNING

This product has an FH3-4 mm/min flame rating and is considered to be flammable. It is advised not to expose this product to open flame or high temperature (over 125° Celsius or 250° Fahrenheit) heating elements.

CTP604



## T h e P h a n t o m L a b o r a t o r y

**Catphan® 604 Manual***Contents*

Warranty	1
Introduction	5
Comparison of Catphan® 604 to Catphan® 504 models	6
Initial phantom positioning	7
Illustration of Catphan® 604 model	8
Phantom position verification	9
Scan section 2: Slice width, sensitometry, pixel size and MTF	10
Patient alignment system check	11
Scan slice geometry (slice width)	12
Scan incrementation	13
Circular symmetry	14
Spatial linearity of pixel size verification	14
CT or Hounsfield Numbers by David Goodenough, Ph.D.	15
Sensitometry (CT number linearity)	16
Point spread function and MTF from bead and wire point sources	18
Use of automated scanner MTF programs	19
5° angled 50 $\mu$ diameter tungsten MTF wire	20
Bead point source for slice sensitivity profile	22
Scan section 1: High resolution with 1 to 15 line pair per cm gauge	23
Scan section 3: CTP730 Low contrast module	24
Scan section 4: Image uniformity section	26
Optional phantom annuli	28
Dose Phantoms	29
Sample quality assurance program	30
Automated computer analysis program	31
Bibliography	32

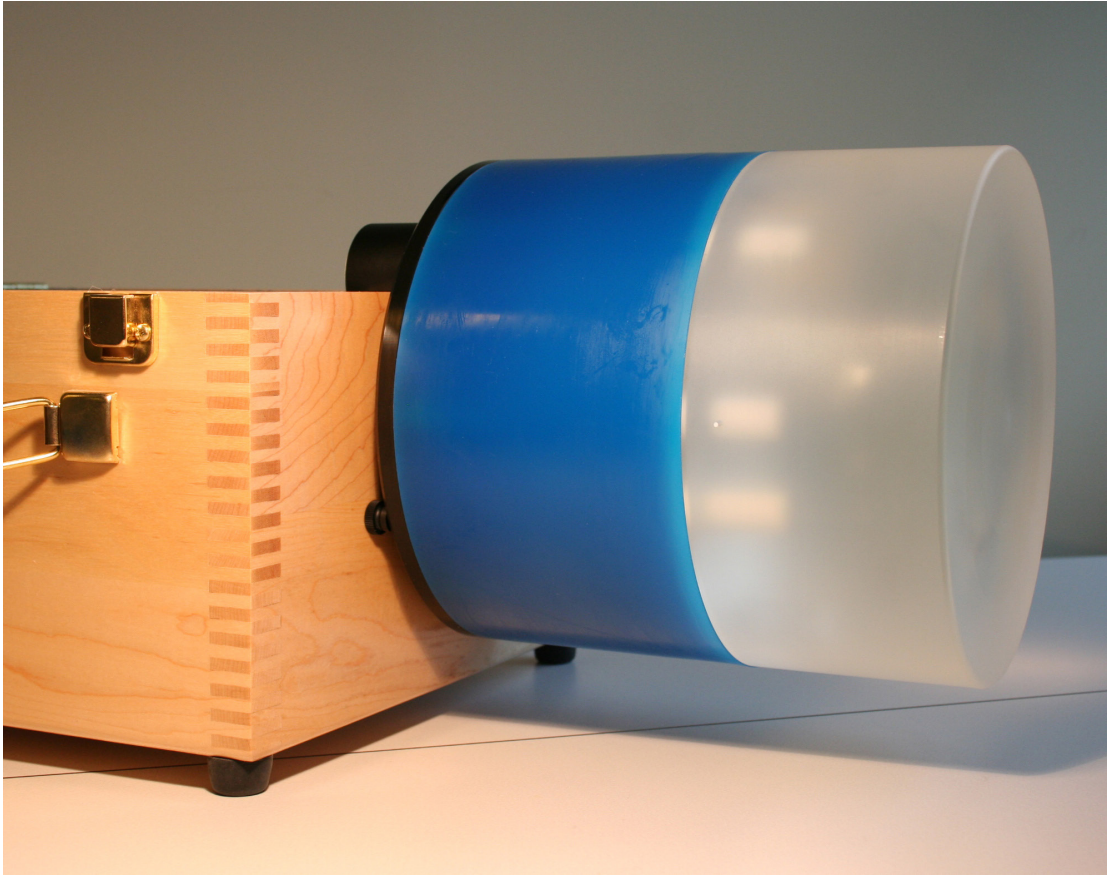

## Introduction

The Catphan® 604 phantom configuration has been selected by Varian Medical Systems. This manual is intended to supplement the Varian CBCT Procedures and Manuals by offering additional details regarding the use of the Catphan® 604 phantom. The Phantom Laboratory and physicist David J. Goodenough, Ph.D., are continually developing and researching new tests and modifications for the Catphan® phantoms. The test objects that make up the current Catphan® models embody more than a quarter century of scientific evaluation and field experience. This manual outlines the applications of each module contained in the Catphan® 604 phantom.

We do not make specific recommendations on the content of your quality assurance program, because each medical imaging facility has its own unique set of requirements. A sample program is provided to give you ideas for possible program content. We suggest a review of local governing regulations, manufacturers' specifications and the needs of your radiologists and physicists before developing your CT quality assurance program.

If you would like a pdf version of this manual it can be downloaded from our website:  
[phantomlab.com](http://phantomlab.com)

If you have any additional questions please contact The Phantom Laboratory at:  
Phone: 800-525-1190 or 518-692-1190  
Fax: 518-692-3329  
email: [sales@phantomlab.com](mailto:sales@phantomlab.com)  
Additional product information is available at: [www.phantomlab.com](http://www.phantomlab.com)

### Comparison of Catphan® 604 to Catphan® 504 models

This manual is to be used with the Catphan® 604 phantom. If you are working with a Catphan® 504 phantom you should use the Catphan® 504 manual. Both of these manuals are available from our website: [phantomlab.com](http://phantomlab.com)

The Catphan® 604 and Catphan® 504 have many similarities, however they are manufactured using some different approaches and there are some differences in test objects.

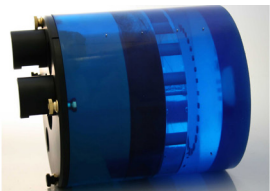
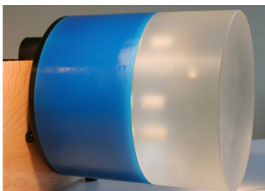
Tests	Catphan® 504	Catphan® 604
		
Slice geometry	23° wire ramps	23° wire ramps
Alignment light verification	Exterior alignment dots require offset	Exterior alignment dots relate to wire ramps
Sensitometry	7 materials including air	9 materials including 2 calcium bone formulations and air
Pixel verification	X and Y targets 5cm spacing	X and Y targets 5cm spacing
High resolution test	1-21 line pair gauge and .28mm MTF bead	1-15 line pair gauge, .18mm MTF bead and .05mm steel MTF wire
Low contrast	1%, 0.5% and 0.3% contrast targets and 1% sub-slice targets	1%, 0.5% and 0.3% contrast targets
Uniformity	Solid cast 15cm diameter	Solid cast 20cm diameter

## Initial phantom positioning

The Catphan® phantom is positioned in the CT scanner by mounting it on the case.

Place the phantom case on the gantry end of the table with the box hinges away from the gantry. It is best to place the box directly on the table and not on the table pads.

Open the box, rotating the lid back 180°. CAUTION: if you are using an annulus, additional weight will need to be placed in the box to counterweigh the phantom. The patient straps can be used for additional stability. See the **Optional phantom annuli** section of this manual for additional information.

Remove the phantom from the box and hang the Catphan® from the gantry end of the box. Make sure the box is stable with the weight of the phantom and is adequately counterweighed to prevent tipping.

Use the level and adjusting thumb screws to level the Catphan®. Once the phantom is level, slide the phantom along the end of the box to align the section center dots on the top of the phantom with the x axis alignment light. Adjust the table height so the lateral height dot aligns with the y axis alignment light.

A scan acquisition covering the length of the phantom will generate an image set with all the required slices of test objects. If you are working with Smári Analysis the image set can be uploaded for a report. For cone beam systems there is a performance difference between the center and edge of the beam. For maximum performance in a specific test center the beam at the section of interest.

Please note the center of the alignment marks on the phantom may vary as much as a millimeter in the z direction from the center of the referenced test slice.

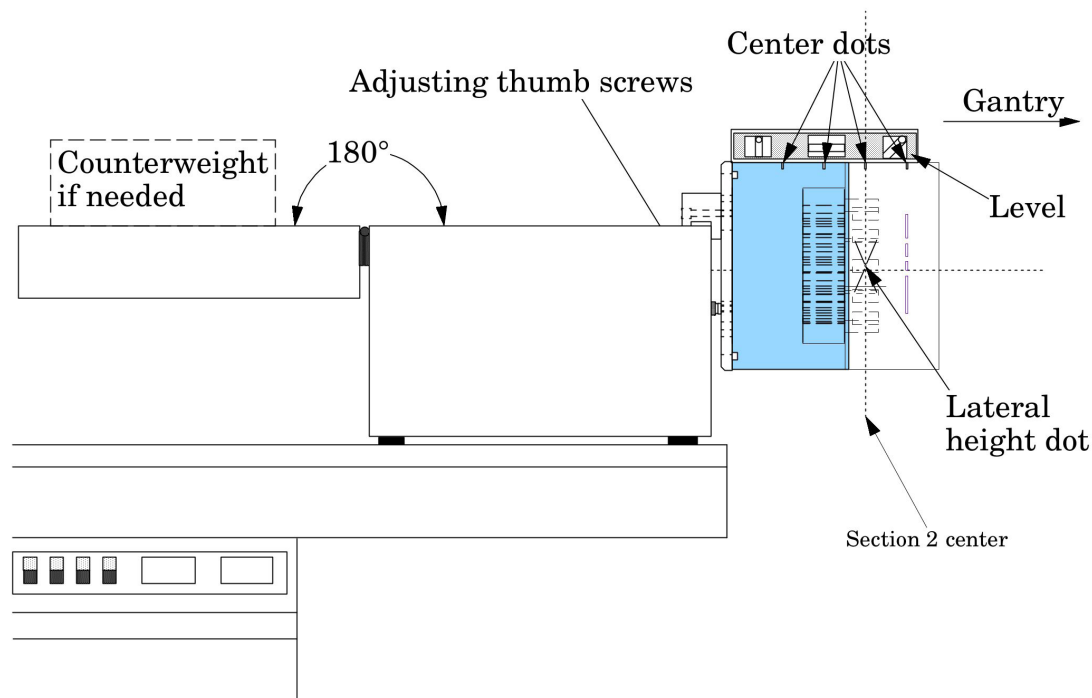

A localizer scan image will show the crossed slice width wires at the z axis center of section 2. By viewing an axial image from the center of Section 2 proper alignment can be verified; see **Phantom position verification** section.

## Illustration of Catphan® 604 model

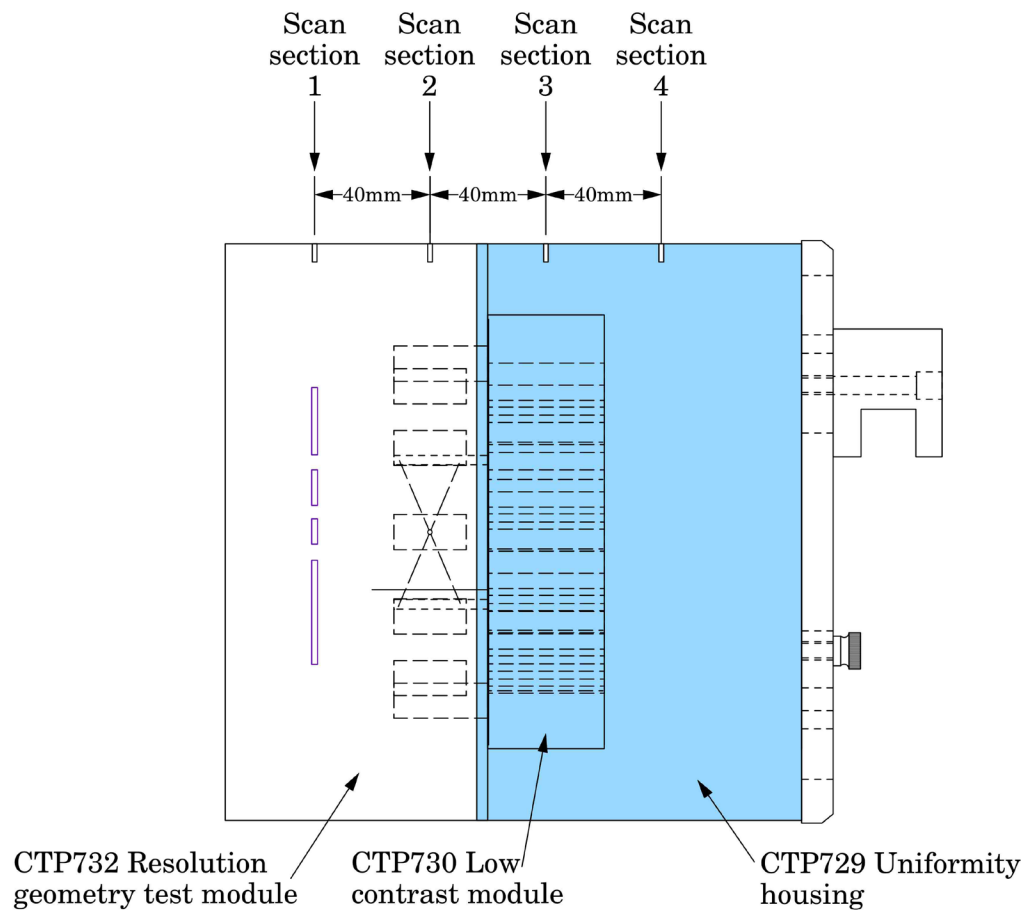

### Incremental scan section positioning

The Catphan®604 phantom is designed so all test sections can be located by indexing the table from the center of scan section 2 to the center of the other test sections and low contrast module. The indexing distances from the center of scan section 2 are listed below. Phantom position and alignment verification is described on the next page.

Catphan® 604 test module locations:

Module	Distance from the center of scan section 2
Scan section 1, 15 line pair high resolution section	-40mm
Scan section 3 CTP730, Low contrast module	40mm
Scan section 4, Solid image uniformity section	80mm



## Phantom position verification

By evaluating an image of scan section 2, the phantom's position and alignment can be verified. This section contains 4 wire ramps which rise at 23° angles from the base to the top of the module. The schematic sketches below indicate how the ramp images change if the scan center is above or below the z axis center of the test module. The use of the scanner's grid image function may assist in evaluation of phantom position.

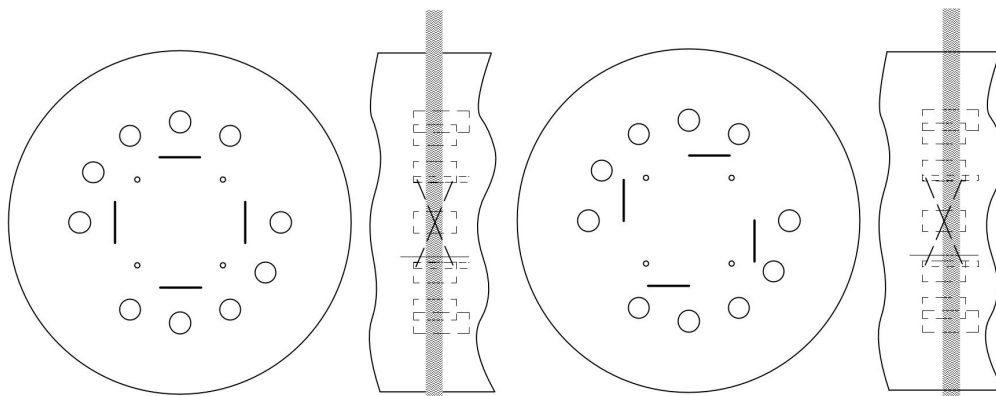

### Correct alignment

In this image the x, y symmetry of the centered ramp images indicates proper phantom alignment.

### Clockwise ramp skew

When the ramps are evenly rotated clockwise from center, the phantom is too far into the gantry.

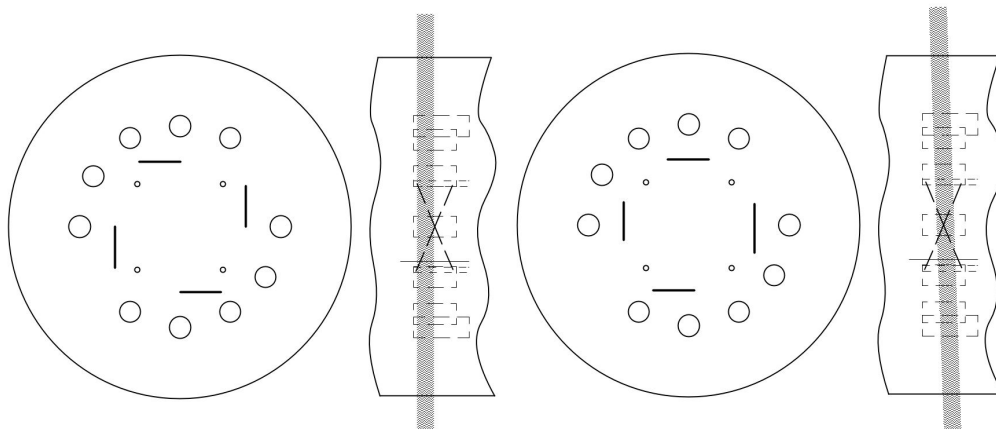

### Counter-clockwise ramp skew

When the ramps are evenly rotated counter-clockwise from center, the phantom needs to be moved toward the gantry.

### Non symmetrical ramp images

Poor alignment with the z axis is indicated when the ramps are not symmetrical in lengths and rotation.

If misalignment is indicated by the scan image, the phantom should be repositioned to obtain proper alignment and then rescanned. If the images of the repositioned phantom duplicate the original misalignment indications, the scanner's alignment lights may require adjustment (contact your local service engineer).

Note: The Catphan® 604 has a snap lock connection between the CTP732 module and the CTP729. Due to this connection there may be up to 1° of rotation around the z axis seen in the phantom images. This can be minimized by securing one end of the phantom and rotating the other so the top alignment dots are aligned. Phantom rotation can also result if the case is rotated on the patient couch.

Once correct alignment has been established, you can proceed with the tests.

**Scan section 2 with slice width, sensitometry, pixel size, MTF bead, and angled wire point source**

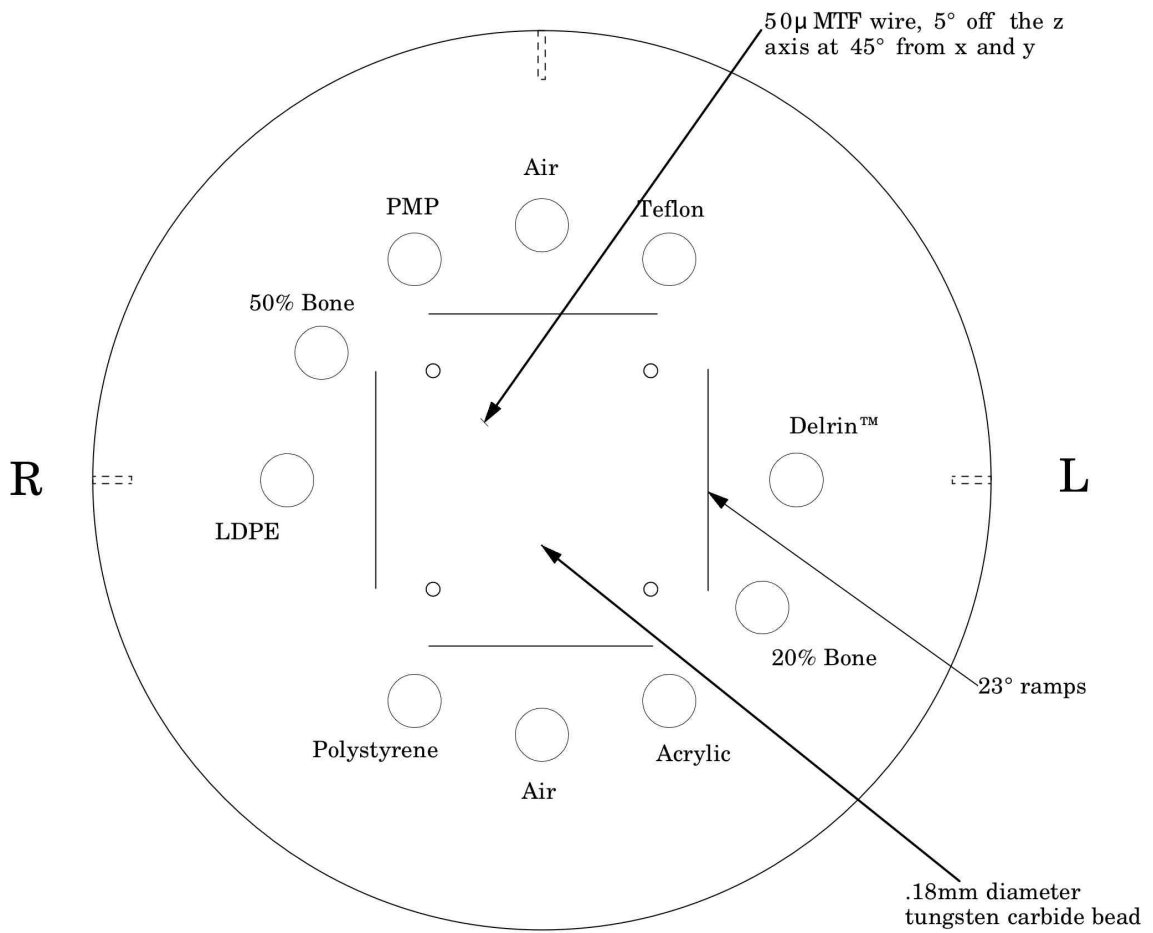

### Patient alignment system check

The laser, optical, and mechanical patient alignment system can be checked. To test external lights, align the white dots on the phantoms scan section 2, with the alignment lights. To test a localization scan, center your slice on the crossed slice width wires. Then scan the phantom.

The scanned image should show good alignment as discussed in Phantom position verification. If the phantom is not aligned with the z axis the A measurement in the sketch below will not be equal and will prevent accurate measurements.

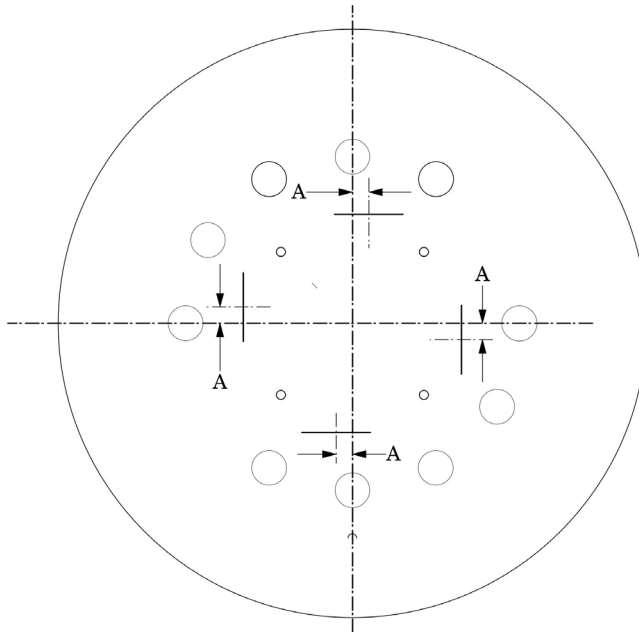

For measuring the z axis alignment lights, measure from the center of the ramp image to the part of the ramp which aligns with the center of the phantom and sensitometry samples. Multiply the distance A by 0.42 to determine the z axis alignment light accuracy. To evaluate x and y accuracy, measure from the center of the phantom to the center of the scan field by use of the grid function or knowledge of the central pixel location.

Please note: while the wire ramps are precisely positioned in the phantom, the 1.6 mm alignment dots can have small variations in position. For this reason, sub-millimeter absolute accuracy should not be expected.

### Scan slice geometry (slice width)

Scan section 2 has two pairs of 23° wire ramps: one pair is oriented parallel to the x axis; the other pair to the y axis. These wire ramps are used to estimate slice width measurements and misalignment errors as previously discussed.

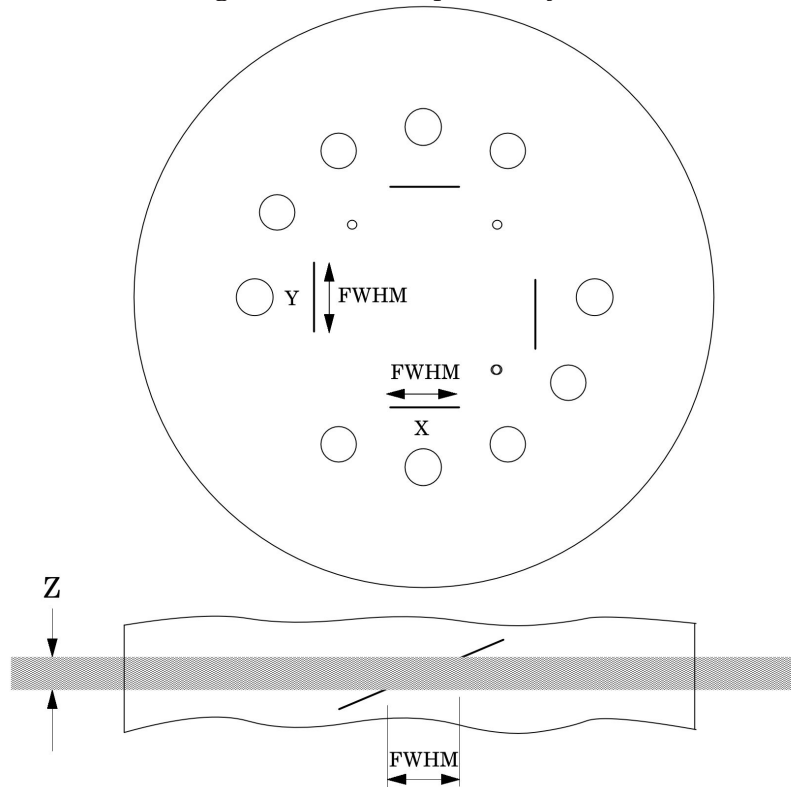

The 23° wire ramp angle is chosen to improve measurement precision through the trigonometric enlargement of 2.38 in the x-y image plane.

To evaluate the slice width (Zmm), measure the Full Width at Half Maximum (FWHM) length of any of the four wire ramps and multiply the length by 0.42:

$$(Z_{mm}) = FWHM * 0.42$$

To find the FWHM of the wire from the scan image, you need to determine the CT number values for the peak of the wire and for the background.

To calculate the CT number value for the maximum of the wire, close down the CT “window” opening to 1 or the minimum setting. Move the CT scanner “level” to the point where the ramp image just totally disappears. The CT number of the level at this position is your peak or maximum value.

To calculate the value for the background, use the region of interest function to identify the “mean” CT number value of the area adjacent to the ramp.

Using the above CT values, determine the half maximum:

First calculate the net peak... (CT # peak - background = net peak CT #)

Calculate the 50% net peak... (net peak CT # ÷ 2 = 50% net peak CT #)

Calculate the half maximum CT number...  
(50% net peak CT # + background CT # = half maximum CT #)

Now that the half maximum CT number has been determined, measure the full width at half maximum of the ramp. Set the CT scanner level at the half maximum CT value and set your window width at 1. Measure the length of the wire image to determine the FWHM. Multiply the FWHM by 0.42 to determine the slice width.

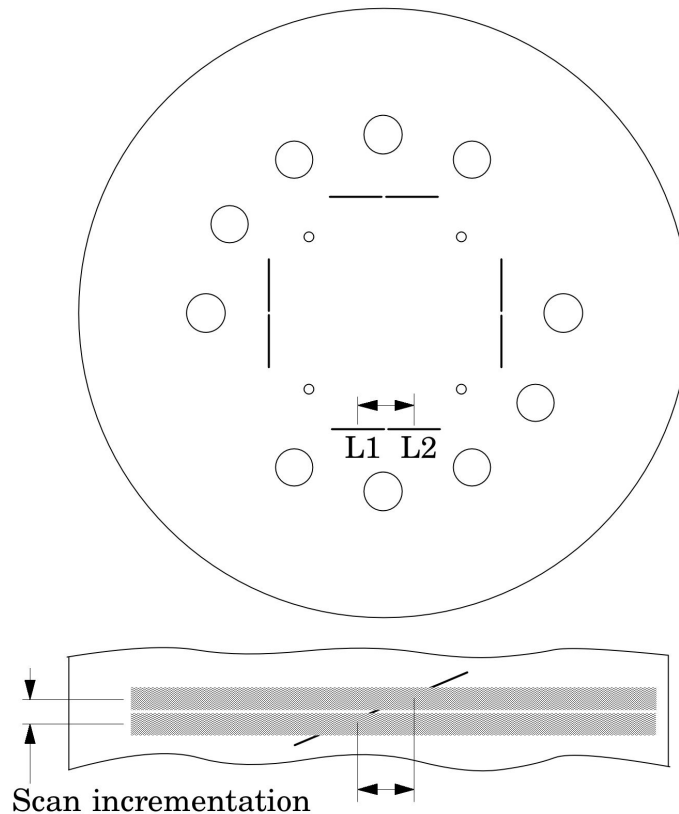

Schematic illustration of two sequential 5mm scans superimposed. L1 is the center point on the 23° ramp in the first scan image and L2 is the center point on the 23° ramp on the second image.

### Scan incrementation

Use the wire ramps to test for proper scanner incrementation between slices, and for table movement.

Scan section 1 using a given slice width, (e.g. 5mm). Increment the table one slice width (e.g. 5mm) and make a second scan. Establish the x and y coordinates for the center of each ramp image. Calculate the distance between these points and multiply by the 23° ramp angle correction factor of 0.42.

$$0.42(L1 - L2) = \text{scan incrementation}$$

This test can also be used to test table increment accuracy. Scan the section and increment the table 30mm in and out of the gantry and scan again. The ramp centers should be the same on both images.

$$0.42(L1 - L2) = 0$$

### Circular symmetry of display system

The circular phantom sections are used to test for circular symmetry of the CT image, including calibration of the CT display system. If an elliptical image is produced, the x-y balance of the image display system should be adjusted.

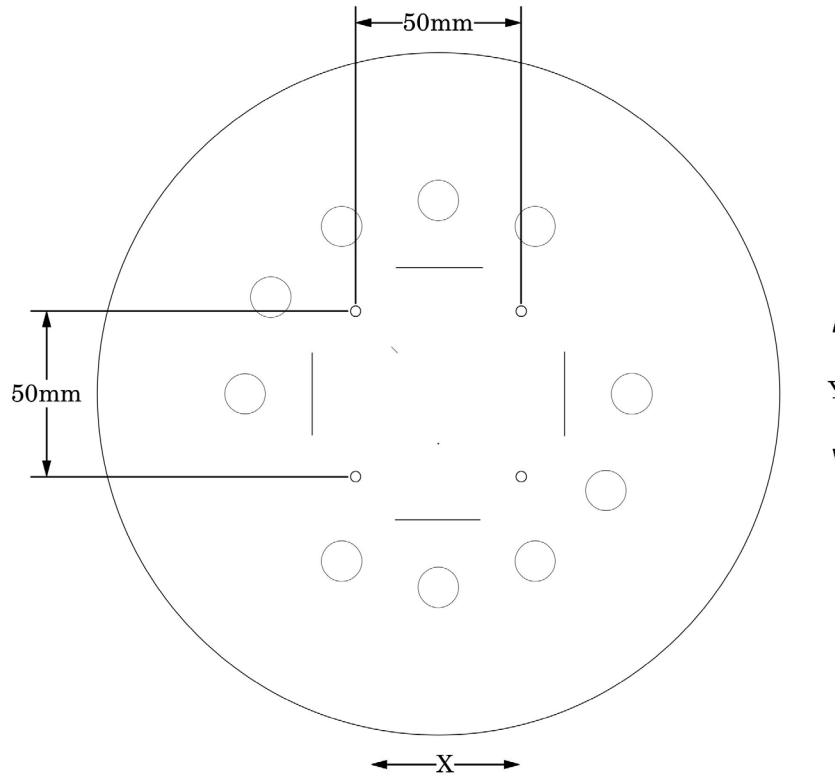

Measuring spatial linearity in x and y axes.

### Spatial linearity of pixel size verification

Scan section 2 has four holes. These 3mm diameter holes are positioned 50mm apart on center. By measuring from center to center the spatial linearity of the CT scanner can be verified. Another use is to count the number of pixels between the hole centers, and by knowing the distance (50mm) and number of pixels, the pixel size can be verified.

## CT or Hounsfield Numbers by David Goodenough, Ph.D.

Users of CT systems are often surprised when the CT number (HU) of a given tissue or substance is different from what they expect from previous experience. These differences do not usually indicate problems of a given CT scanner, but more likely arise from the fact that CT numbers are not universal. They vary depending on the particular energy, filtration, object size and calibration schemes used in a given scanner. One of the problems is that we are all taught that the CT number is given by the equation:

$$CT\# = k(\mu - \mu_w)/\mu_w,$$

where  $k$  is the weighting constant (1000 is for Hounsfield Scale),  $\mu$  is the linear attenuation coefficient of the substance of interest, and  $\mu_w$  is the linear attenuation coefficient of water. Close review of the physics reveals that although the above equation is true to first order, it is not totally correct for a practical CT scanner. In practice,  $\mu$  and  $\mu_w$  are functions of energy, typical x-ray spectra are not monoenergetic but polychromatic, and a given spectrum emitted by the tube is “hardened” as it is transmitted (passes) through filter(s) and the object, finally reaching the detector. More accurately,  $\mu = \mu(E)$ , a function of energy. Therefore:

$$CT\#(E) = k(\mu(E) - \mu_w(E))/\mu_w(E)$$

Because the spectrum is polychromatic we can at best assign some “effective energy”  $\hat{E}$  to the beam (typically some 50% to 60% of the peak kV or kVp). Additionally, the CT detector will have some energy dependence, and the scatter contribution (dependent on beam width and scanned object size, shape, and composition) may further complicate matters. Although the CT scanner has a built in calibration scheme that tries to correct for beam hardening and other factors, this is based on models and calibration phantoms that are usually round and uniformly filled with water, and will not generally match the body “habitus” (size, shape, etc.).

The situation is really so complicated that it is remarkable that tissue CT numbers are in some first order ways “portable”!

In light of the above we can examine a parameter of CT performance, the “linearity scale”, as required by the FDA for CT manufacturer’s performance specifications.

The linearity scale is the best fit relationship between the CT numbers and the corresponding  $\mu$  values at the effective energy  $\hat{E}$  of the x-ray beam.

The effective energy  $\hat{E}$  is determined by minimizing the residuals in a best-fit straight line relationship between CT numbers and the corresponding  $\mu$  values.

In review, we will encounter considerable inter and intra scanner CT number variability. CT numbers can easily vary by 10 or more based on kVp, slice thickness, and object size, shape, and composition. There is some possibility of the use of iterative techniques and/or dual energy approaches that might lessen these effects, but certainly CT numbers are not strictly portable and vary according to the factors listed above.

More complete scientific references are contained in the bibliography. In particular, references 2, 13, 14, and 20 are recommended for those with greater interest in the topic.

### Sensitometry (CT number linearity)

Scan section 2 has sensitometry targets made from Teflon®, Bone 50%, Delrin®, Bone 20%, acrylic, Polystyrene and low density polyethylene (LDPE), polymethylpentene (PMP), Lung foam #7112 and air. The module is also equipped with a small removable vial which can be filled with water or other material and inserted into the CTP682 module.

These targets range from approximately +1000 HU to -1000 HU. A table with the linear attenuation coefficient  $\mu$  [units  $\text{cm}^{-1}$ ] can be downloaded from our web site.

The monitoring of sensitometry target values over time can provide valuable information, indicating changes in scanner performance. Note: values can change depending on local temperature and pressure.

#### Nominal material formulation and specific gravity

Material	Formula	$Z_{\text{eff}}^1$	Specific Gravity <sup>2</sup>	HU range <sup>3</sup>
Air	.78N, .21O, .01Ar	8.00	0.00	-1046 : -986
PMP	[C <sub>5</sub> H <sub>8</sub> O <sub>2</sub> ]	5.44	0.83	-220 : -172
LDPE	[C <sub>2</sub> H <sub>4</sub> ]	5.44	0.92	-121 : -87
Polystyrene	[C <sub>8</sub> H <sub>8</sub> ]	5.70	1.03	-65 : -29
Acrylic	[C <sub>5</sub> H <sub>8</sub> O <sub>2</sub> ]	6.47	1.18	92 : 137
Bone 20%	.51C, .06Ca, .06H, .06N, .30O, .03P	9.09	1.14	211 : 263
Delrin®	Proprietary	6.95	1.42	344 : 387
Bone 50%	.35C, .14Ca, .04H, .06N, .34O, .06P	11.46	1.40	667 : 783
Teflon®	[CF <sub>2</sub> ]	8.43	2.16	941 : 1060

#### Electron density and relative electron density

Material	Electron Density ( $10^{23}$ e/g)	Electron Density ( $10^{23}$ e/cm <sup>3</sup> )	Relative Electron Density <sup>4</sup>
Air	3.002	0.004	0.001
PMP <sup>5</sup>	3.435	2.851	0.853
LDPE <sup>6</sup>	3.435	3.160	0.945
Polystyrene	3.238	3.335	0.998
Acrylic	3.248	3.833	1.147
Bone 20%	3.178	3.623	1.084
Delrin®	3.209	4.557	1.363
Bone 50%	3.134	4.387	1.312
Teflon®	2.890	6.243	1.868

<sup>1</sup>  $Z_{\text{eff}}$ , the effective atomic number, is calculated using a power law approximation.

<sup>2</sup> For standard material sensitometry inserts The Phantom Laboratory purchases a multiple year supply of material from a single batch. Samples of the purchased material are then measured to determine the actual specific gravity. The specific gravity of air is taken to be .0013 at standard temperature and pressure.

<sup>3</sup> These are maximum and minimum measured values from a sample of 94 scans using different scanners and protocols typically at 120 kVp. HU can vary dramatically between scanners and imaging protocols and numbers outside of this range are not unusual.

<sup>4</sup> Relative Electron Density is the electron density of the material in e/cm<sup>3</sup> divided by the electron density of water (H<sub>2</sub>O) in e/cm<sup>3</sup>.

<sup>5</sup> Polymethylpentene

<sup>6</sup> Low Density Polyethylene



An excel file with the linear attenuation coefficient  $\mu$  [units  $\text{cm}^{-1}$ ] for the sensitometry materials can be downloaded from our web site.

### **Mass attenuation coefficients**

An excel file with the mass attenuation coefficients [units  $\text{cm}^2/\text{g}$ ] and densities for the sensitometry materials can be downloaded from our website [phantomlab.com](http://phantomlab.com).

### **Contrast Scale**

Contrast Scale (CS) is formally defined as

$$\text{CS} = \frac{\mu_m(E) - \mu_w(E)}{CT_m(E) - CT_w(E)}$$

where m is reference medium, and w is water, and E is the effective energy of the CT beam.

$$\text{Alternatively, CS} = \frac{\mu_1(E) - \mu_2(E)}{CT_1(E) - CT_2(E)}$$

where 1,2 are two materials with low z effective, similar to water (eg. acrylic & air).  
Linear attenuation coefficient  $\mu$  [units  $\text{cm}^{-1}$ ]

## Point spread function and MTF from bead and wire point sources

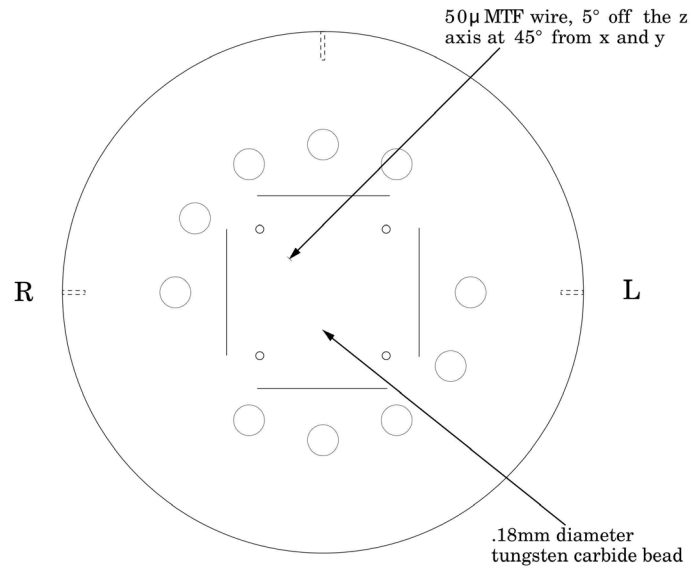

The impulse sources (.18mm bead or 5° angled 50 micron wire) are used to measure the point source response function of the CT system.

The tungsten carbide bead has a diameter of 0.18mm. Because the bead is subpixel sized it is not usually necessary to compensate for its size. However, some MTF programs are designed to compensate for its size.

The FWHM of the point spread function is determined from the best-fit curve of the point spread function numerical data.

The average of several different arrays of impulse response functions is calculated to obtain the average point spread function of the system. These numerical values are used in conjunction with the Fourier transform to provide an estimate of the two-dimensional spatial frequency response characteristics of the CT system (MTF).

PSF (normalized CT values)				
0.5	-2	-3	-2	0.5
-4	3	17	3	-4
-2	44	100	44	-2
-2	44	100	44	-2
-4	3	17	3	-4
0.5	-2	-3	-2	0.5

  

LSF				
-11	90	228	90	-11

pixel

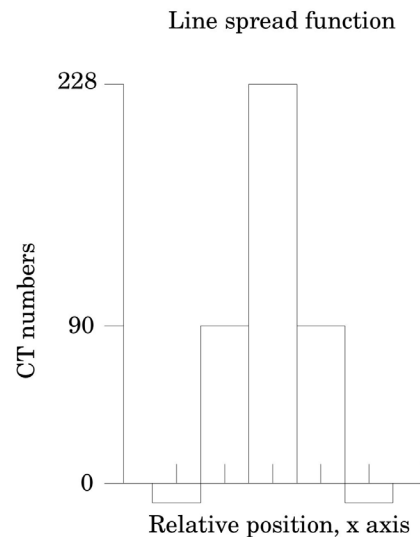

The above illustration shows how by summing the columns (y axis) of numbers in the point spread function (PSF) the line spread function (LSF) for the x axis is obtained.

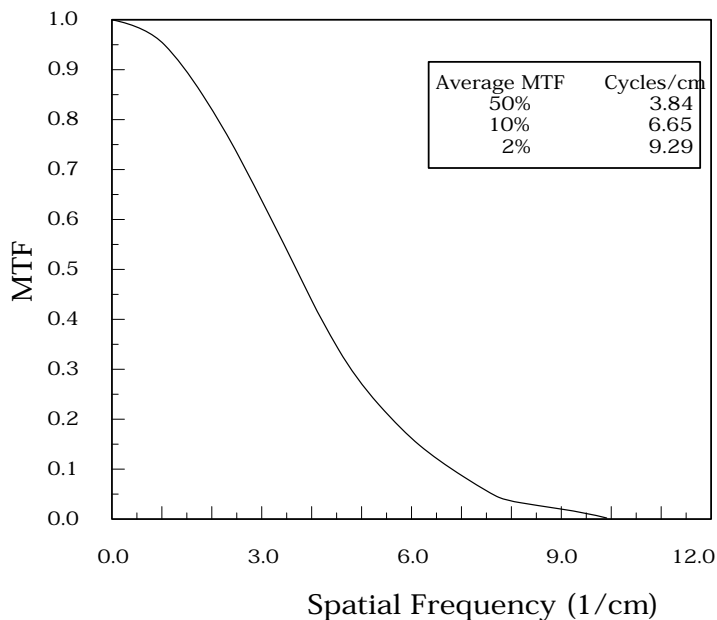

The MTF curve results from the Fourier transform of the LSF data. Generally, it is easiest to use automated software for this operation. Some CT scanners are supplied with software which can calculate the MTF from the Catphan® bead images. Independent software is listed in the **Current automated programs available** section of the manual.

#### **Use of automated scanner MTF programs**

Because the bead is cast into a urethane background, which has a different density than water, the any automated software must compensate for the background. Some software may require point size of .18mm must also be selected. While a sphere does produce a different density profile than a cross section of a wire or cylinder, the actual difference is not usually significant in the determination of the MTF in current CT scanners.

### 5° angled 50 $\mu$ diameter tungsten MTF wire

The tungsten wire and the .18mm bead are used as point sources for the calculation of the Modulation Transfer Function (MTF). Traditionally the MTF wire is positioned parallel with the z axis. However, in this phantom the 50 $\mu$  wire has a 5° angle to the z axis offering some advantages and limitations in volume acquisition. When simple point spread plots from a given slice are used in calculating the MTF, the position of the wire ramp overlapping two or more pixels can cause distorted results.

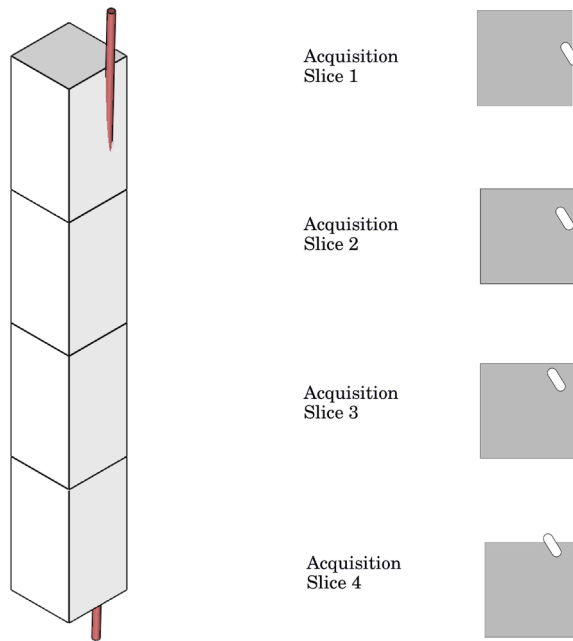

Illustration of 4 slices with voxels on the left and pixel view on the right. In slice 2 and 3 the wire is within the pixel and on slices 1 and 4 it is also in neighboring pixels.

When the angled wire is used, it moves across voxel columns as it passes through slices as shown in the illustration above. In some slices, it will be in multiple voxels and in others a single voxel. For this reason when calculating the MTF from the angled wire, several slices need to be used and the lower frequency measurements need to be eliminated. The lower measurements probably result from the pixel cross over of the wire. The remaining higher frequency results should give a good indication of the resolution. To the right of the 3-D illustration are axial views of the wire location within a pixel. The oval shape illustrates how the wire moves through pixels as it moves through the slices.

If thicker slices are used, the length of the oval will extend and the measurement will deteriorate as shown in the illustration on the next page. For this reason we recommend the use of the bead for calculating the MTF in thicker slices. However, determining the largest acceptable slice thickness is dependent on the actual scanner x-y resolution (including the pixel size). Therefore, with higher resolution thinner slices will be required for accurate measurements when using the 5° wire.

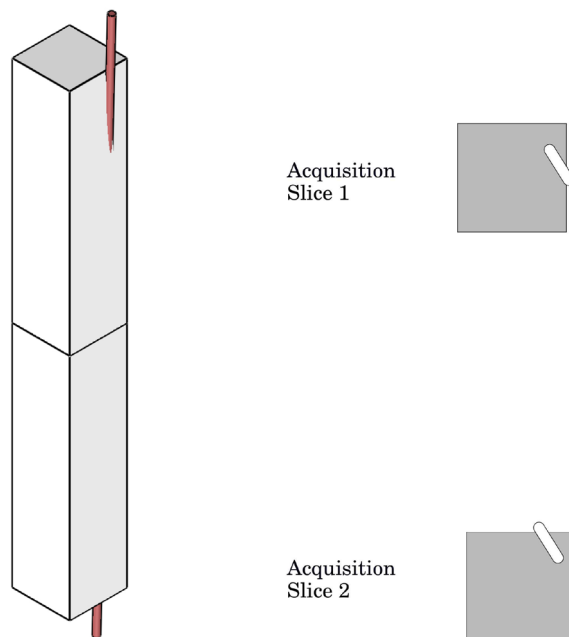
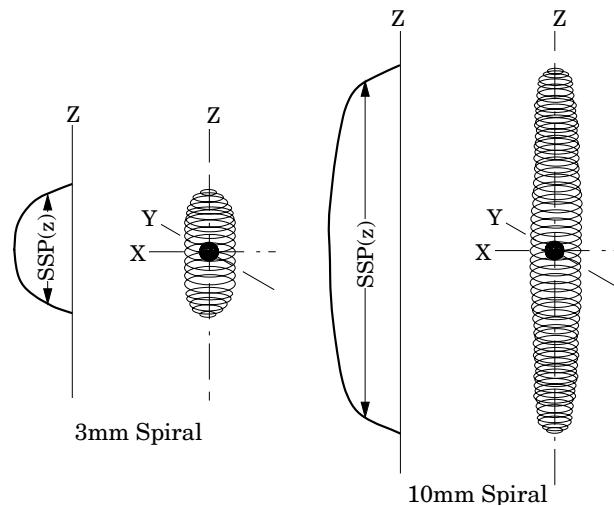

Illustration of 2 thicker slices on the left and pixel view on the right. In these thicker slices the wire is not contained within any of the pixels.

In advanced MTF calculations, as used by the Image Owl Catphan® QA service, multi-axis mathematical considerations are included in the MTF calculation, minimizing the effects created when the MTF wire or bead is located in multiple pixels in a slice. However, this may not compensate entirely for the angled MTF wire when used with thicker slices.

### Bead point source for slice sensitivity profile

The bead in this module can be used to calculate the slice sensitivity profile (SSP).



The above image illustrates how the bead will produce an ovoid object in a 3 dimensional reconstruction. The length of the object at the Full Width at Half Maximum signal indicates the SSP. This measurement can be easily obtained on some systems, by making a sagittal or coronal reconstruction through the bead. The bead image in these reconstructions will appear as a small line. By setting the FWHM (use the same technique described in the **Scan slice geometry** section) measuring the z axis length of the bead image to obtain the SSP.

If the scanner does not have the ability to measure z axis lengths in the sagittal or coronal planes, a SSP can be made by incrementing or spiraling the slice through the bead and reconstructing images in positive and negative table directions from the bead (using the smallest available increments) and plotting the peak CT number of the bead image in each slice. The FWHM measurement can then be made from the plotted CT values of the bead as a function of z axis table position.

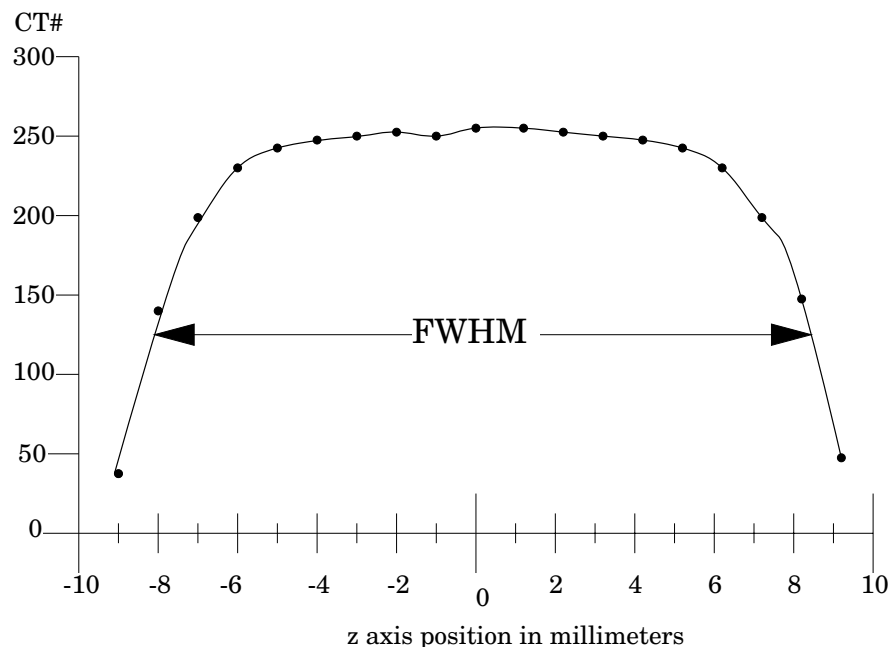

### Scan section 1 with 15 Line pair per centimeter high resolution gauge

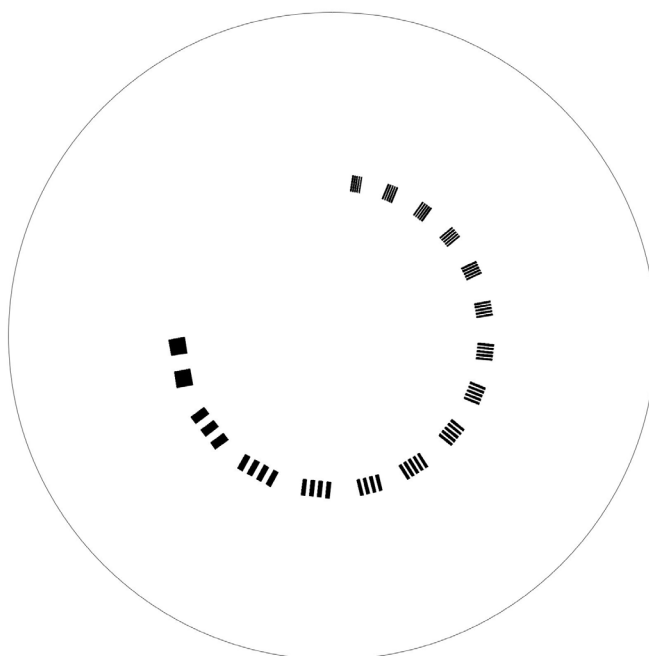

This section has a 1 through 15 line pair per centimeter high resolution test gauge.

The 15 line pair/cm gauge has resolution tests for visual evaluation of high resolution ranging from 1 through 15 line pair/cm. The gauge accuracy is  $\pm 0.5$  line pair at the 15 line pair test and even better at lower line pair tests.

The gauge is cut from 2mm thick aluminum sheets and cast into the urethane background. Depending on the choice of slice thickness, the contrast levels will vary due to volume averaging.

Line Pair/cm	Gap Size
1	0.500 cm
2	0.250 cm
3	0.167 cm
4	0.125 cm
5	0.100 cm
6	0.083 cm
7	0.071 cm
8	0.063 cm

Line Pair/cm	Gap Size
9	0.056 cm
10	0.050 cm
11	0.045 cm
12	0.042 cm
13	0.038 cm
14	0.036 cm
15	0.033 cm

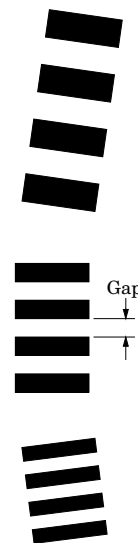

### Scan section 3 with CTP730 low contrast module

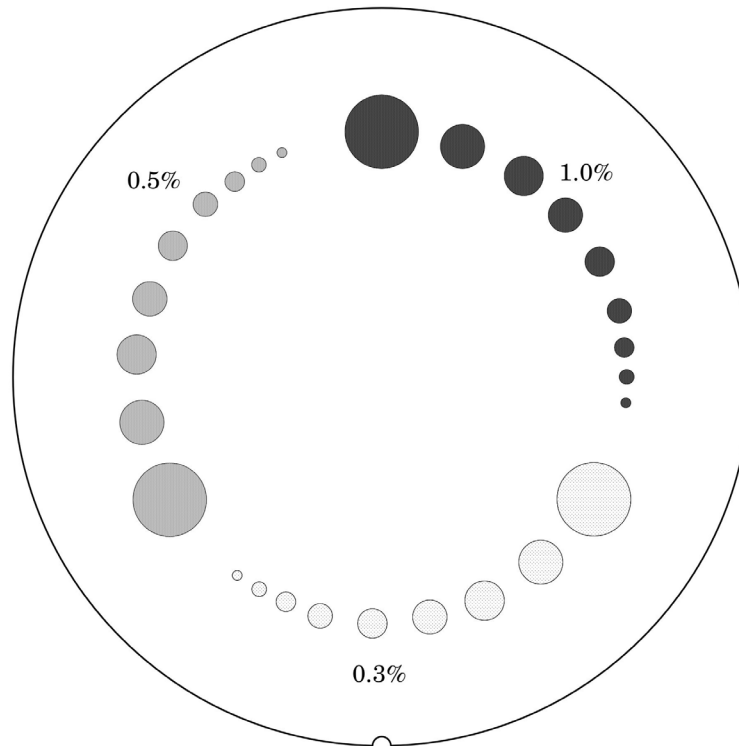

The low contrast targets have the following diameters and contrasts:

The low contrast target rods are 40mm long and have the following diameters:

2.0mm  
3.0mm  
4.0mm  
5.0mm  
6.0mm  
7.0mm  
8.0mm  
9.0mm  
15.0mm

Nominal target contrast levels

.3%  
.5%  
1.0%

Since the target contrasts are nominal, the actual target contrasts need to be determined before testing specific contrast performance specifications. The actual contrast levels are measured by making region of interest measurements over the larger target, and in the local background area. To determine actual contrast levels, average the measurements made from several scans. It is important to measure the background area adjacent to the measured target because “cupping” and “capping” effects cause variation of CT numbers from one scan region to another.

Position the region of interest to avoid the target edges. The region of interest should be at least 4 x 4 pixels in diameter. Because low contrast measurements are “noisy” it is advisable to calculate the average of the multiple measurements made from several scans. Carefully monitor the mAs setting because the photon flux will improve with increased x-ray exposure. Use the size of the targets visualized under various noise levels to estimate information on contrast detail curves.



All of the targets in each contrast group are cast from a single mix to assure that the contrast levels will be the same for all targets.

The equation below can be used to convert the measured contrasts and diameters to other specified contrasts and diameters.

$$(\text{Measured Contrast}) * (\text{smallest diameter discernible}) \cong \text{Constant}$$

$$\text{example: } 5\text{mm diameter @ } 0.3\% \cong 3\text{mm diameter @ } 0.5\%$$

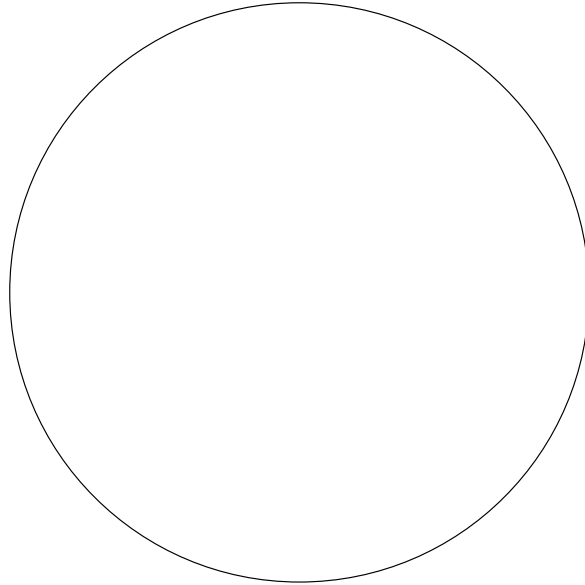
**Scan section 4, Image uniformity**

The image uniformity section is cast from a uniform material. The material's CT number is designed to be within 2% (20H) of water's density at standard scanning protocols. The typically recorded CT numbers range from 5H to 18H. This module is used for measurements of spatial uniformity, mean CT number and noise value and certain types of artifacts.

The precision of a CT system is evaluated by the measurement of the mean value and the corresponding standard deviations in CT numbers within a region of interest (ROI). These measurements are taken from different locations within the scan field.

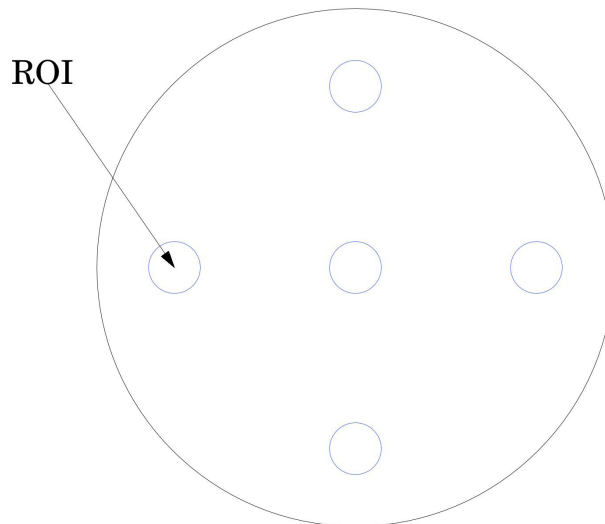

The mean CT number and standard deviation of a large number of points, (say 1000 for example) in a given ROI of the scan, is determined for central and peripheral locations within the scan image for each type of scanning protocol. Inspect the data for changes from previous scans and for correlation between neighboring slices.

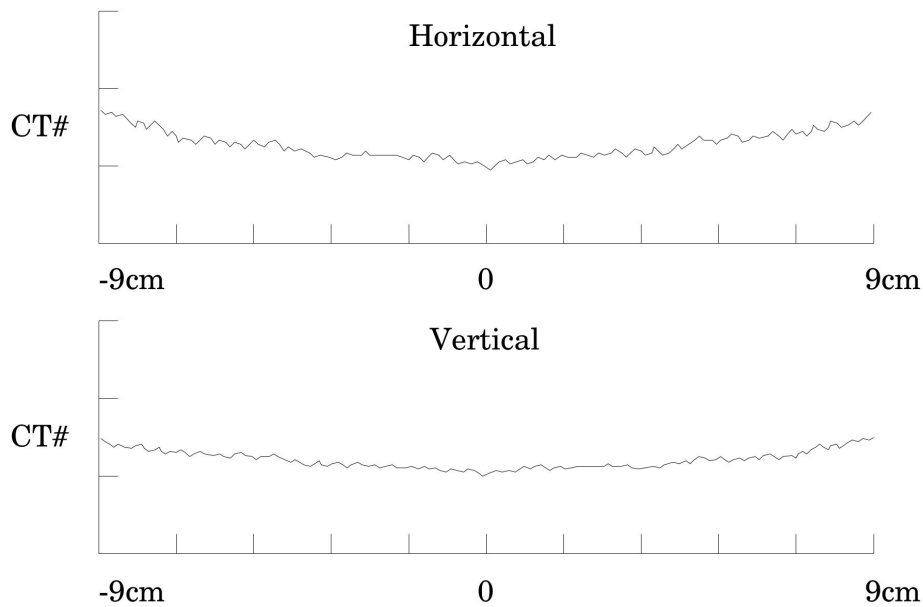

Measure spatial uniformity by scanning the uniformity section. Observe the trends above and below the central mean value of a CT number profile for one or several rows or columns of pixels as shown above.

Select a profile which runs from one side of the uniformity module to the opposite side. Due to scanner boundary effects, typical profiles start 1 to 2cm from the edge of the phantom or test module.

Integral uniformity may be measured by determining the minimum and maximum CT values along the profile and by using the following equation :

$$\text{Integral Non-Uniformity} = \frac{CT_{\text{max}} - CT_{\text{min}}}{CT_{\text{max}} + CT_{\text{min}}}$$

The phenomenon of “cupping” or “capping” of the CT number may indicate the need for recalibration. This type of non-uniformity may be considered as an “artifact” if it exceeds several Hounsfield units.

Another type of artifact can present as one or more circles or circular bands. This may need to be monitored and possibly corrected if the amplitude or level of the circles and bands might obscure or distract from clinical data.

Note: This module does not generate other types of artifacts such as streaking or comet tails that are created by high contrast items contained in other sections.

### Optional phantom annuli

#### Warning

Before mounting a Catphan® phantom with an annulus onto the Catphan® case, the case must be secured to the table by use of the patient restraint straps or additional weight. If the case is not secured to the table when the phantom is mounted, the case, phantom and annulus could fall off the edge of the table. Additionally the snap lock connection between the clear section and blue section of the phantom could release when excessive pressure is placed on it.

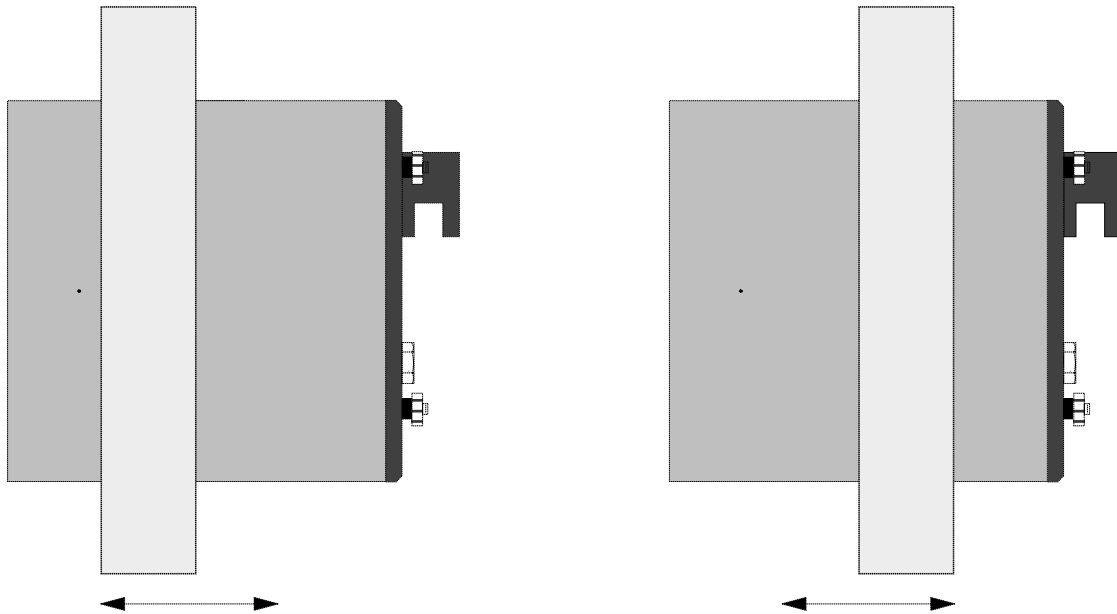

The Phantom Laboratory offers a variety of oval and round annuli sizes for use with the Catphan® phantoms. Please contact the company for information on available sizes and prices.

The annuli are designed to slide over the 20cm Catphan® housing as illustrated above. Because the housing material and the uniformity annuli lack lubricity, the annuli may not slide easily. By adding water based lubricant the resistance can be reduced.

## Dose Phantoms

The CTP553 and CTP554 dose phantoms are designed to the Food and Drug Administration's Center for Devices and Radiological Health specification, listed in 1020.33.

The dose phantoms may be mounted on the Catphan® case following the same procedures and precautions used in Initial phantom positioning. The holes will accept a 1/2" or 13mm diameter dose probe.

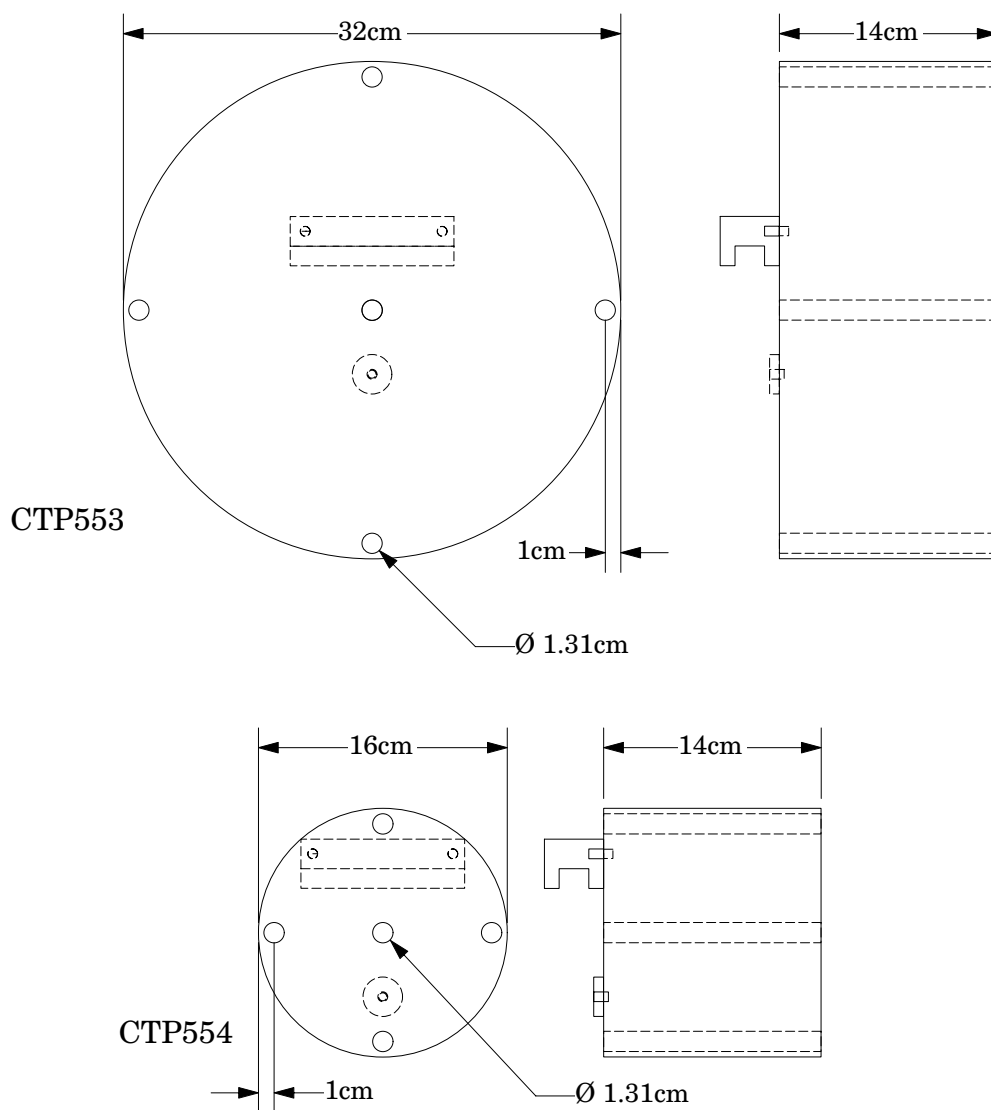

### Warning

Make sure the Catphan® case is secure. Additional counterweight may be required before mounting 32cm dose module onto case.

**Sample quality assurance program**

The following shows a sample QA program. Review the local governing requirements, and the needs of your physicians and physicists when developing a QA program for your institution. This program should only be considered as a sample.

All tests should be conducted at initial acceptance and after major repairs such as a tube replacement. Perform the weekly tests after each preventative maintenance.

## Suggested frequency of tests:

	Daily	Weekly	Monthly*
Positional verification	•	•	•
Circular symmetry			•
Scan slice geometry		•	•
Impulse response function			•
Resolution		•	•
Low contrast		•	•
Contrast Sensitivity		•	•
Uniformity, noise characteristics and artifacts	•	•	•

\*or following preventative maintenance

### **Automated computer analysis**

To assist our customers, The Phantom Laboratory has worked with Image Owl, Inc. to develop an automated QA cloud-based service. The Image Owl Catphan® QA service offers detailed CT performance testing and reports with the versatility of internet access. This service can be used with Catphan® 500, 503, 504, 600, 604, and 700 models.

Along with automated image processing and reporting, Image Owl offers additional advanced tools and services, including longitudinal history, with a subscription to the service.

Test reports include:

- TG142 summary
- Spatial resolution (modulation transfer function)
- Noise and image uniformity
- Slice width and pixel size
- Sensitometry (CT# linearity, input - output relationship)
- Contrast detectability (C-D model)

Please contact Image Owl for information on the services available.

imageowl.com  
info@imageowl.com

### **Commercial automated software**

There are now several commercial companies which offer stand-alone software, or incorporate the ability to analyze Catphan® images as a part of their software package.

## Bibliography

1. AAPM Report No. 39  
Specification and Acceptance Testing of Computed Tomography Scanners  
Report of Task Group 2 Diagnostic X-Ray Imaging Committee. Published for the  
American Association of Physicists in Medicine by the American Institute of Physics.  
May 1993
  
2. M. J. Berger, J. H. Hubbell, S. M. Seltzer, J. Chang, J. S. Coursey, R. Sukumar, and D.  
S. Zucker, Feb. 2009, XCOM: Photon Cross Sections Database, NIST Standard Reference  
Database 8 (XGAM), <http://www.nist.gov/physlab/data/xcom/index.cfm> (July 7, 2010).
  
3. Brooks and DiChiro  
Principles of Computer Assisted Tomography (CAT) in Radiographic and  
Radioisotopic Imaging  
Phys Med Biol 1976:21:689-732
  
4. Cohen and DiBanca  
The Use of Contrast-Detail-Dose Evaluation of Image Quality in a Computed  
Tomographic Scanner  
Comput. Assist. Tomogr. 3, 189-195 1979
  
5. Goodenough  
Assessment of Image Quality of Diagnostic Imaging Systems  
In: Gray GA (ed). Medical images: formation, perception and measurements. Proceedings  
of the 7th L.H.Gray Conference, New York: John Wiley & Sons, 1976:263-77
  
6. Goodenough  
Automated Quality Assurance for CT Scanners  
(Chapter): Radiology ICR 749, Editors Silver, Abecasis and Veiga-Pires. Excerpta Medica  
Press, Amsterdam 1987
  
7. Goodenough  
Psychophysical Perception of Computed Tomography Images  
In: Newton and Potts (eds). Radiology of the skull and brain: technical aspects of  
computed tomography. Vol 5, St. Louis: CV Mosby, 1981:3993-4021
  
8. Goodenough and Atkins  
Theoretical and Practical Aspects of Automated Quality Assurance Approaches,  
Particularly for CT  
Proceedings of the ICR 89, Excerpta Medica Press, Amsterdam 1990
  
9. Goodenough and Weaver  
Factors Related to Low Contrast Resolution in CT Scanners  
Computerized Radiology Vol. 8 No, 5. 279-308 1984
  
10. Goodenough, Weaver, and Davis  
Development of a Phantom for Evaluation and Assurance of Image Quality in  
CT Scanning  
The Proceedings of the Application of Optical Instrumentation in Medicine V meeting  
sponsored by The Society of Photo-Optical Instrumentation Engineers and The Society  
of Photographic Scientists and Engineers, September 16-19, 1976, Washington DC; and,  
Optical Engineering, January 1977
  
11. Goodenough, Weaver, and Davis  
Potential Artifacts Associated with the Scanning Pattern of the EMI Scanner  
Radiology 117:615-620, December 1975



12. Goodenough, Weaver, and Davis  
Physical Measurement of the EMI Imaging System  
In: Ter-Pogossian, Phelps, Brownell, Cos Jr., Davis and Evens (eds). Reconstruction tomography in diagnostic radiology and nuclear medicine. Baltimore: University Park Press, 1977: 225-243
13. John M. Boone and J. Anthony Seibert, 1997, An accurate method for computer-generating tungsten anode x-ray spectra from 30 to 140 kV, Medical Physics, v. 24, No. 11, p. 1661-1670.
14. R. J. Kriz and Keith J. Strauss, 1985, An investigation of computed tomography (CT) linearity, Medical Imaging and Instrumentation, v. 555, p. 195-204.
15. McCullough  
Photon Attenuation in Computed Tomography  
Medical Physics, 2:307-320, Nov/Dec 1975
16. McCullough, Baker, Hattery, Sheedy, Stephens and Payne  
Performance Evaluation and Quality Assurance of Computed Tomography (CT) Equipment with Illustrative Data for ACTA, Delta , and EMI Scanners  
Radiology 120: 173-188, July 1976
17. McCullough, Baker, Houser, and Reese  
An Evaluation of the Quantitative and Radiation Features of Scanning X-ray Transverse Axial Tomography: the EMI Scanner  
Radiology 111: 709-715, June 1974
18. Phelps, Hoffmar-Pogossian  
Attenuation Coefficients of Various Body Tissues, Fluids and Lesions at Photon Energies of 18 to 136 keV  
Radiology 117:573-583, December 1975
19. Rossmann  
Point Spread Function, Line Spread Function and Modulation Transfer Function: Tools for the Study of Imaging Systems  
Radiology 1969:93:257-72
20. T. R. Fewell, R. E. Shuping, and K. E. Healy, 1981, Handbook of Computed Tomography X-ray Spectra, HHS Publication (FDA) 81-8162 (U.S. Government Printing Office, Washington D.C.).
21. Weaver, Goodenough, and Briefel  
Sensitometry in Computerized Tomography  
Proceedings of SPIE, Medicine VI. 1977:127:87-94
22. Yester and Barnes  
Geometrical Limitations of Computed Tomography (CT) Scanner Resolution  
Optical instrumentation in Medicine VI. SPIE, 1977:127:296-303
23. International Commission on Radiatin Units and Measurements  
Tissue Substitutes in Radiation Dosimetry and Measurement  
ICRU Report 44
24. Klein, Hanley, Bayouth, Yin, Simon, Dresser, Serago, Aguirre, Ma, Arjomandy, Liu, Sandin and Holms  
Quality Assurance of Medical Accelerators

AAPM Task Group 142 report

25.

Hatton, McCurdy and Greer

Cone beam computerized tomography: the effect of calibration of the Hounsfield unit number to electron density on dose calculation accuracy for adaptive radiation therapy

Physics in Medicine and Biology August 2009

26.

Thomas

Relative electron density calibration of CT scanners for radiotherapy treatment planning

British Journal of Radiology 72(860):781-6, August 1999