

part number
CTP540

page 1 of 1

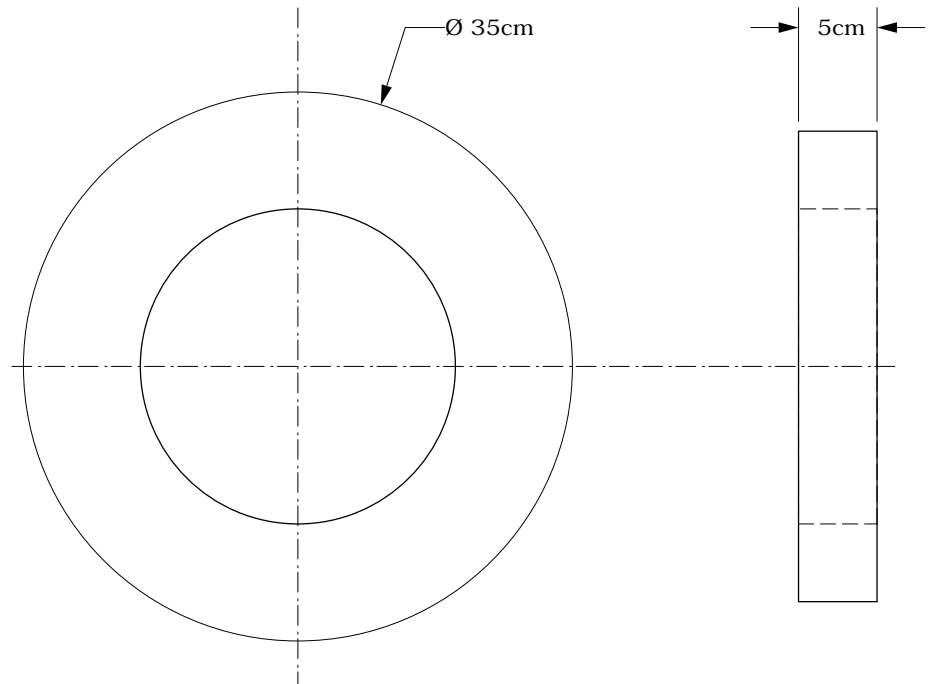

35cm OD Uniformity Material Body Annulus, CTP540

The 35cm body annulus can be slid over a 20cm Catphan® housing to mimic body imaging attenuation. The annulus is cast from our uniformity material that is within 2% (0-20H) of water density.



The Phantom Laboratory

phone
800-525-1190 or 518-692-1190
fax
518-692-3329

mail
P.O. Box 511
Salem, New York 12865
shipping
2727 State Route 29
Greenwich, New York 12834

email
info@phantomlab.com
web
www.phantomlab.com